

IO-ADPT

IO LINK – RF ADAPTOR

Item ref: 124.158UK

User Manual

Thank-you for choosing this IO Link RF adaptor. Designed for use with satellite boxes that do not have an RF2 output. This device converts the I/O port to an RF2 output allowing the use of a TV link or magic eye remote extender. The adaptor also has a RF loop through input to allow reception of DTV signal for additional TV sets.

Specification:

I/O Input	10 pin din plug on 240mm lead
RF Input	RF socket
RF Output	RF plug (channel 21 – 69)
Dimension	60 x 50 x 21mm
Weight	75g

Installation:

Before installation please ensure that both TV and Sky box are disconnected from mains power.

- Connect adaptor to satellite box through the 10-pin DIN connector ensuring it is correctly in-line.
- Connect RF output to a magic eye device and then connect to the TV.
- Connect UHF aerial to RF input (if required).

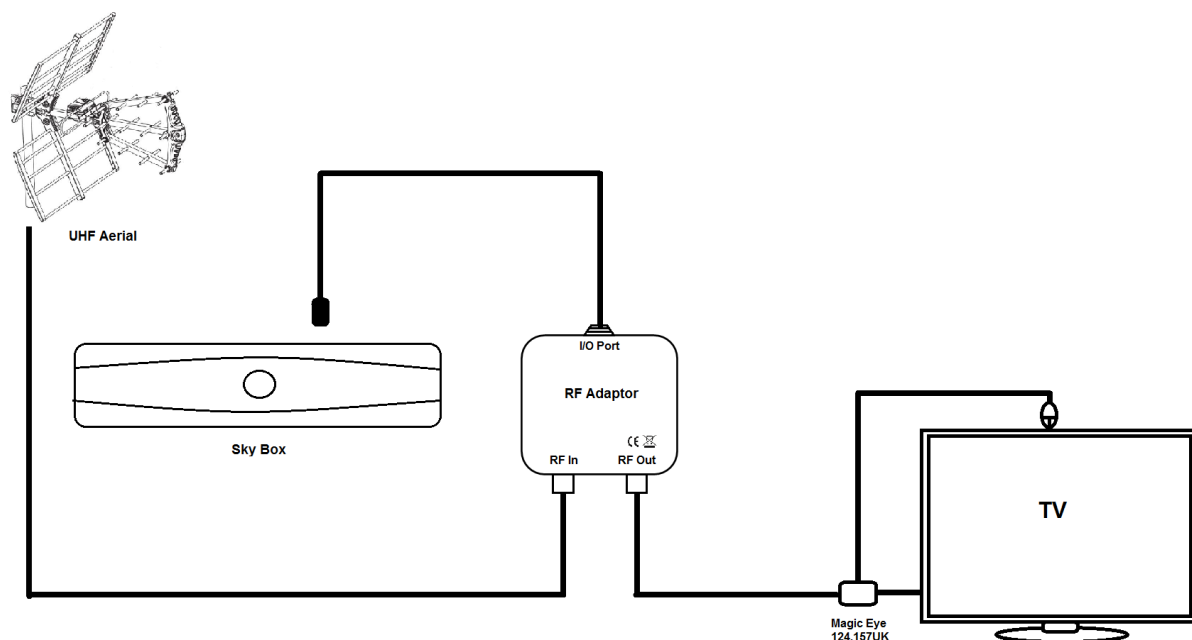

For set-ups with more than one TV, a distribution amplifier with DC pass facility can be used, such as Mercury's AMD & AMS ranges. See diagram below:

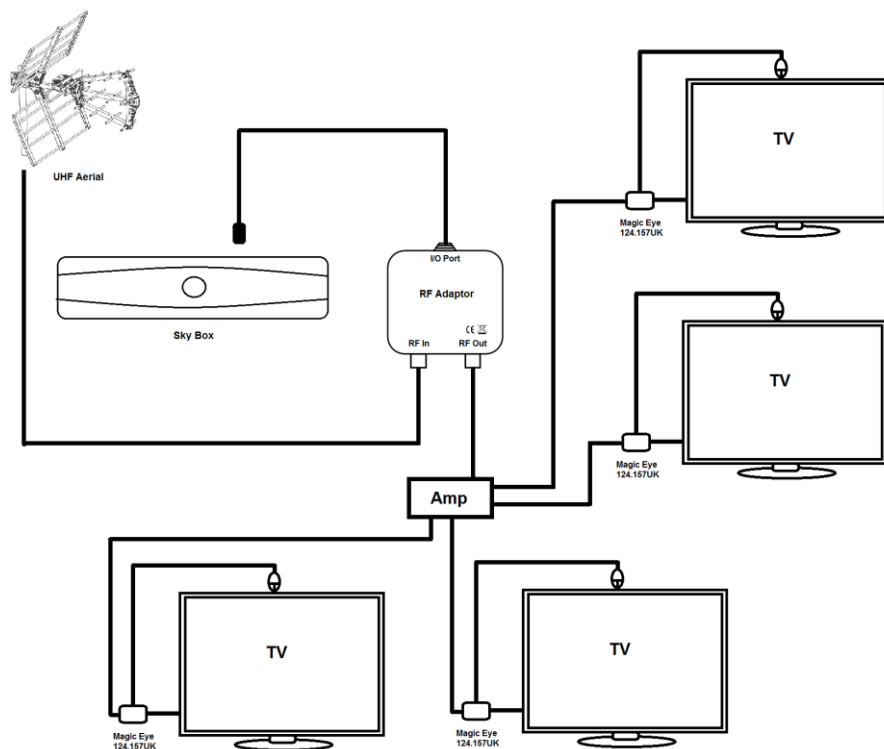

Set-up

For the adaptor to work correctly, RF output power must be switched on via the satellite box.

To activate your IO Link adaptor on a Sky+HD box:

- Using your Sky remote control press "SERVICES".
- Press "0" then "0" then "1" then "SELECT" to enter the installer set-up menu.
- Press the down arrow button to navigate to "RF Outlet Power Supply" and change the setting on "On".
- Press the GREEN button to save the change.
- Retune your TV in analogue mode (not DTV mode).



This product is classed as Electrical or Electronic equipment and should not be disposed with other household or commercial waste at the end of its useful life. The goods must be disposed of according to your local council guidelines.